

COOK CONCRETE PRODUCTS, INC.

—Precast—



MANHOLE PIPE • DRAINAGE INLETS • STORM WATER/OIL INTERCEPTORS • UTILITY VAULTS & BOXES • CUSTOM PRECAST

(530) 243-2562
 FAX (530) 243-6881
 www.cookconcreteproducts.com
 e-mail:
 Info@cookconcreteproducts.com

5461 EASTSIDE ROAD
 P.O. BOX 720280
 REDDING, CA 96099

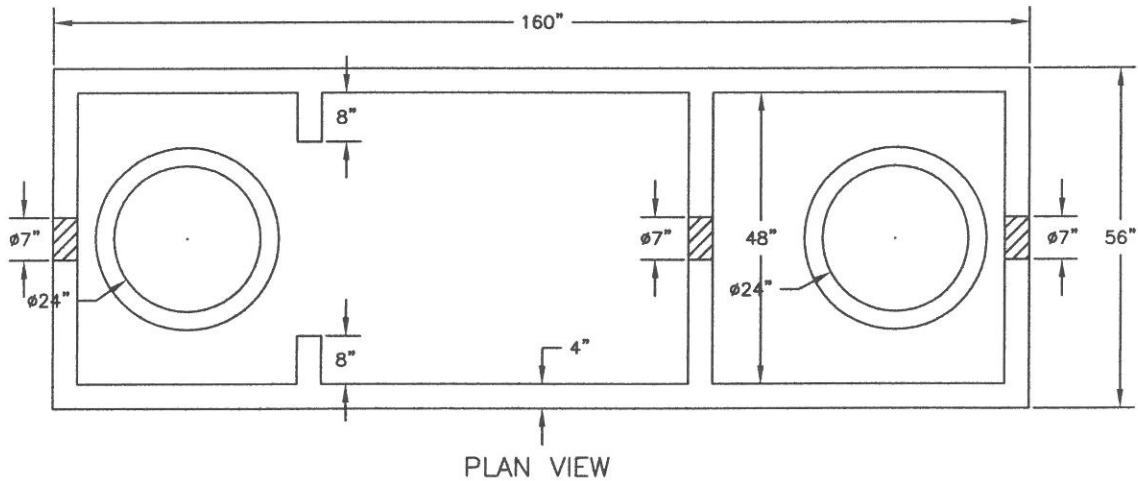
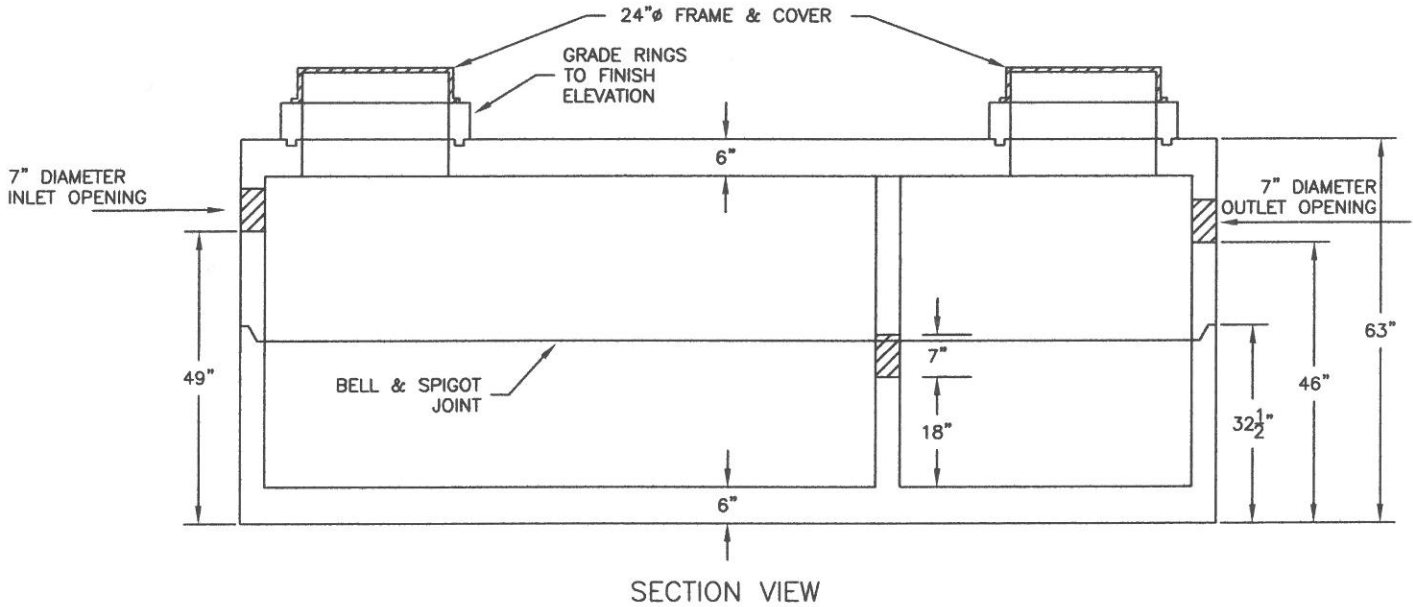

NOTES:

- 1) DESIGNED FOR H-20 HIGHWAY LOADING.
- 2) PENETRATION SIZES AND LOCATIONS CAN BE PLACED AS REQUIRED.
- 3) WEIGHT PER SECTION: 8,950 LB.
- 4) 3 COMPARTMENT TANK AVAILABLE AS STORM WATER INTERCEPTOR.
- 5) OUTLET BOXES AVAILABLE, SEPARATE ITEM.
- 6) ALSO AVAILABLE IN 1500, 2000, 3000, 4000 AND 5000 GALLON CAPACITIES.
- 7) PLUMBING TEES FURNISHED BY OTHERS

1,250 GALLON GREASE INTERCEPTOR