

MANHOLE PIPE • DRAINAGE INLETS • STORM WATER/OIL INTERCEPTORS • UTILITY VAULTS & BOXES • CUSTOM PRECAST

(530) 243-2562
FAX (530) 243-6881
www.cookconcreteproducts.com
e-mail:
Info@cookconcreteproducts.com

5461 EASTSIDE ROAD
P.O. BOX 720280
REDDING, CA 96099

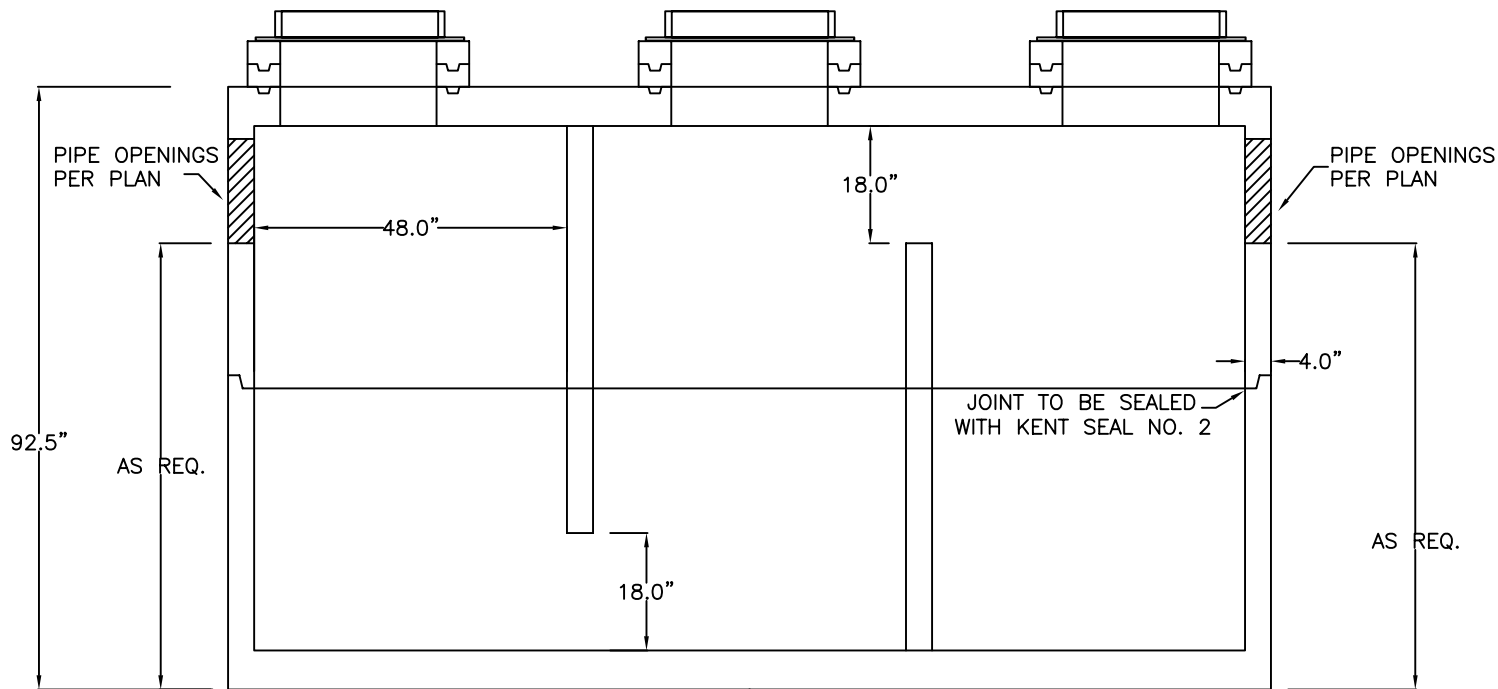

SIDE VIEW

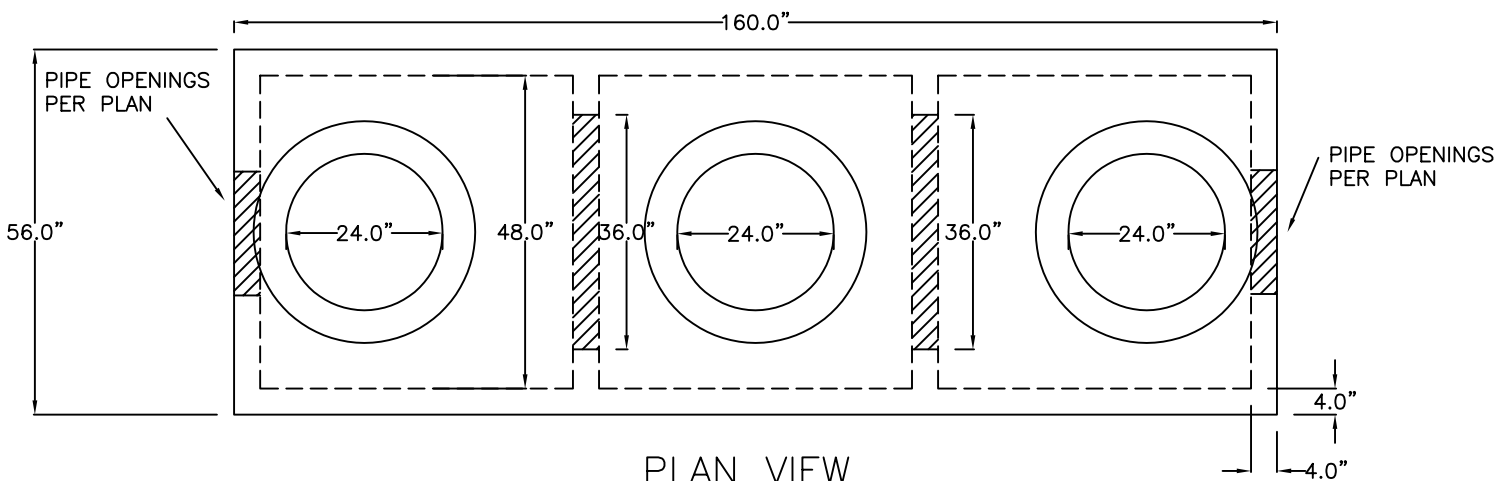

PLAN VIEW

- DESIGNED FOR HS-20 HIGHWAY LOADING.
- PENETRATION SIZES AND LOCATIONS CAN BE PLACED AS REQUIRED.
- AVAILABLE SIZES 500, 750, 1250, 1500, 2000, 3000, 4000 & 5000.
- CUSTOM TANKS AVAILABLE UP TO 10,000 GALLONS

2000 GALLON STORMWATER INTERCEPTOR